

Geofón

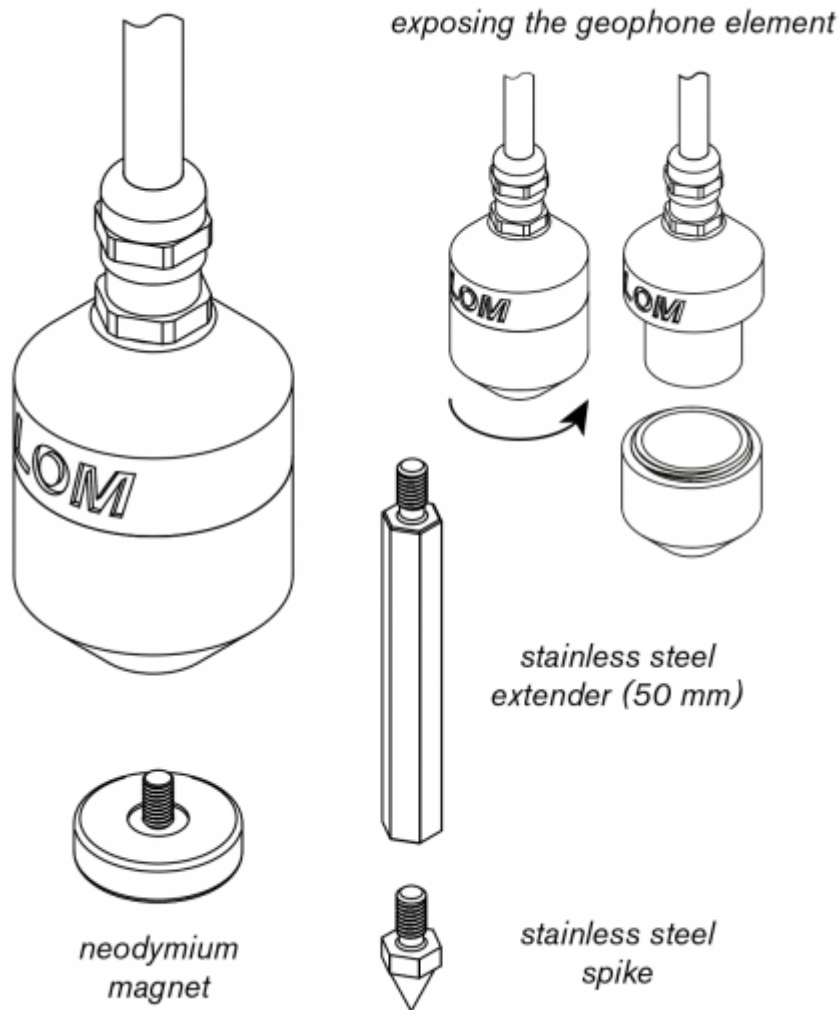



Geofón is a sensitive geophone adjusted for field recording purposes. Originally designed for seismic measurements, it can be used with regular field recording equipment to capture very faint vibrations in various materials and even soil.



Neodymium magnets may cause interference with credit cards (magnetic stripes), cardiac pacemakers and ICDs.



Due to the nature of the geophone sensor, you may experience picking up electromagnetic interference in specific urban areas and other places with strong electromagnetic fields

How to use Geofón

Geofón is a robust geophone designed to be used both outdoors and indoors. It is weather-resistant, but not waterproof.

Bottom of the case has a M4 thread, where you can attach either provided neodymium magnet or the spike (via extender).

For sensitive measurements, you can unscrew the bottom plastic part of the geophone to expose the element. You can attach the element using chewing gum-like adhesive used for hanging posters.

Clinking sound when moving the geophone is normal and expected.

Treat your geophone with the respect it deserves 😊

Technical specifications

Geophone	
Frequency response	10 Hz - 1000+ Hz
Impedance	3500 Ω
Resonant frequency	14 Hz
Open-circuit sensitivity	80.0 V/m/s
Cable	1.5m, robust polyurethane jacket, shielded
Output	XLR-3M balanced, gold-plated black Neutrik connector

From:

<http://knowledge.lom.audio/> - **LOM knowledge base**

Permanent link:

<http://knowledge.lom.audio/manuals/geofon?rev=1579185541>

Last update: **2020/01/16 15:39**

